



# COMERCO ERCOLE

## MECHANICAL CONSTRUCTIONS

21052 Busto Arsizio (Va) Italy - via Castellanza, 100  
tel. +39 0331 488411 - Fax +39 0331 488421  
Customer Service: fax +39 0331 488513



Quality &   
Technology  
Since 1885

# CALENDARIO CALENDAR 2012



[info@comercole.it](mailto:info@comercole.it) - [www.comercole.it](http://www.comercole.it)

SINCERT



SINCERT



# ENGINEERING DIVISION

Comerio Ercole S.p.A. is one of the most qualified European mechanical manufacturers with a worldwide production program for a range of special machines and complete plants.



COMERC INTERNATIONAL S.r.l.



COMERC ENGINEERING S.r.l.



The productive synergies, derived from an integrated quality system organization TQA ISO 9001, enable Comerio Ercole S.p.A. to offer competitive prices improving constantly its standard of quality and technology.

**Quality & Technology**

Since 1885



**COMERIO ERCOLE**  
MECHANICAL CONSTRUCTIONS





Choose the Original  
Choose Success!

# NONWOVENS DIVISION



- Thermal bonding calenders with 2, 3 or 4 rolls arrangement
- Gauging and laminating calenders
- Glazing calenders
- Embossing calenders
- High speed calenders
- High pressure calenders
- Peripherally drilled rolls with smooth or engraved face

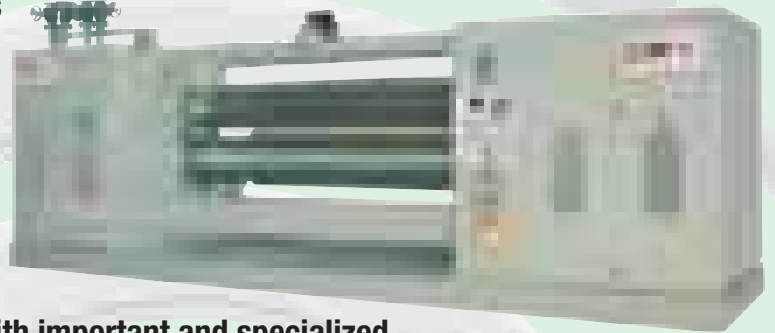

- Comerio Ercole in collaboration with important and specialized companies can supply complete nonwovens plants (Spunbonding/Thermobonding technology)



High speed up to 800 m/min  
Wide width up to 5,500 mm  
Heating up to 300 °C ± 1°C accuracy

*Quality &*  
**Technology**

Since 1885



**COMERIO ERCOLE**  
MECHANICAL CONSTRUCTIONS

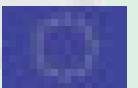



Choose the Original  
Choose Success!

# PLASTIC DIVISION

- 2-3 roll calenders with different configuration
- Revamping of existing calendering lines
- 2 roll calenderlines for PVC or LINOLEUM flooring (tiles and sheets)
- Laboratory mixing mills
- Calenderlines for bi-adhesive tapes
  - "CEMA" Calenderlines
  - Coupling and Laminating

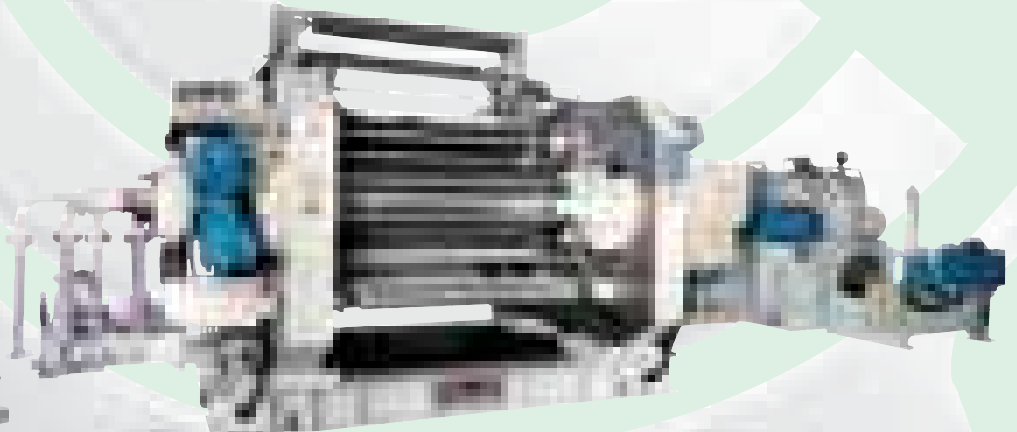
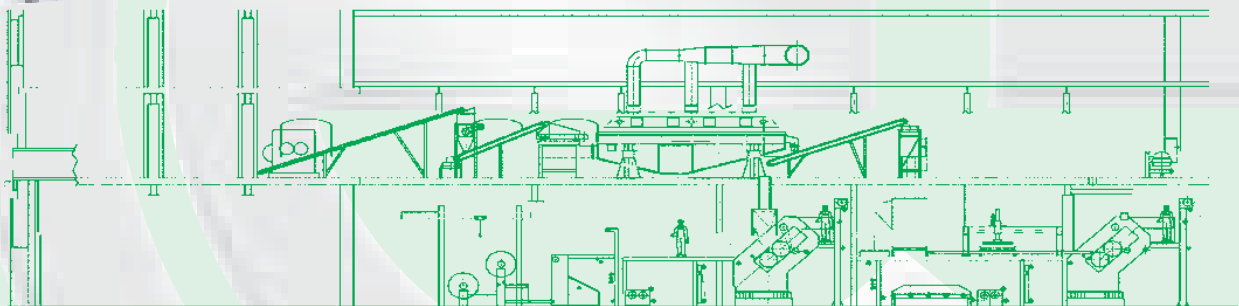
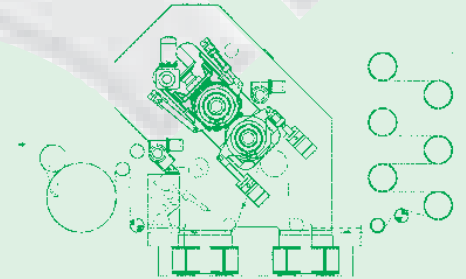

**Quality & Technology**  
Since 1885



**COMERIO ERCOLE**  
MECHANICAL CONSTRUCTIONS

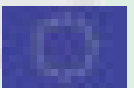



# CKA

**ALLIANCE FOR  
PLASTIC INDUSTRY**

21052 Busto Arsizio (VA) - ITALY  
Via Castellanza 100  
Tel + 39 0331488-411  
Fax + 39 0331488-421  
www.comercole.it  
info@comercole.it

**COMERIO ERCOLE**  
MECHANICAL CONSTRUCTIONS SINCE 1885 - ITALY

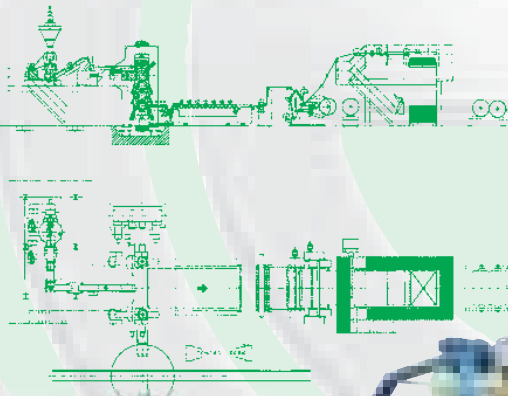
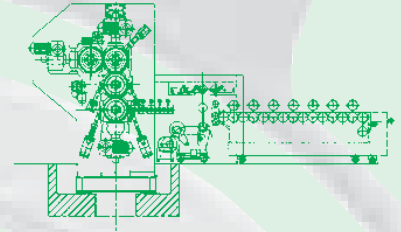

- 4 and 5 roll calenders with L or F configuration
- Complete calendering lines for Rigid, Semirigid or Soft PVC, TPO, PP or PU
- Complete calendering plant including raw material handling, extrusion and feeding system
- Revamping of existing calendering lines
- Customized Engineering and process solution provider
- Technical & Technological Know How
- Turn key project



**Quality &  
Technology**  
Since 1885

**COMERIO ERCOLE**  
MECHANICAL CONSTRUCTIONS





Choose the Original  
Choose Success!

# RUBBER DIVISION



- Internal Mixer MCC series with capacity from 2 up to 270 liters - 2 and 4 wing rotors.
- Mixing Mills series MGN and MGP with roll face from 300 up to 2540 mm.
- Complete mixing plants.
- Roller head and profiling calenders.
- 2, 3 and 4 roll calender with I,L,F,S, Inclined configuration.
- Complete calendering lines for rubberizing of fabrics, steel and textile cord.
- Complete calendering lines for rubber sheeting.

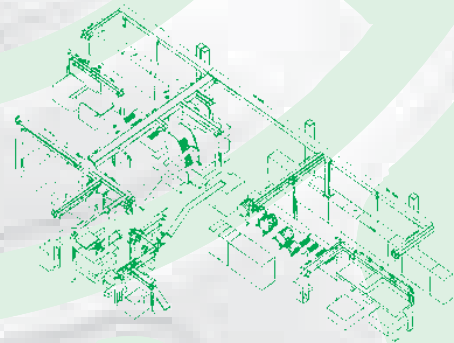
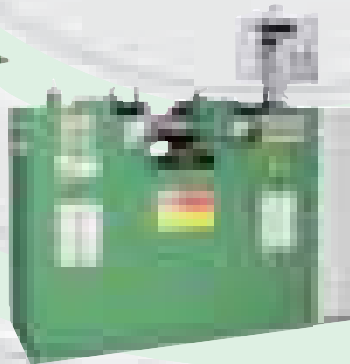
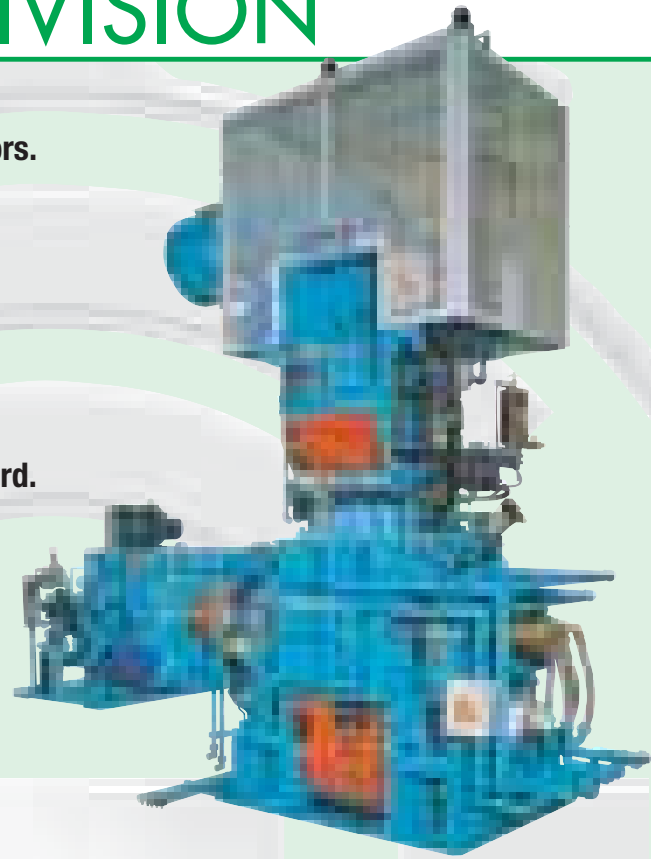

*Quality &*  
**Technology**

*Since 1885*



**COMERIO ERCOLE**  
MECHANICAL CONSTRUCTIONS

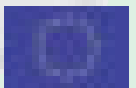

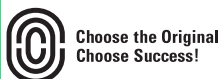

# QUALITY PROOF



Comerio Ercole, in the logic of “Customers Satisfaction”, has recently defined a new company trade-mark named “Comerio Ercole Quality Proof Made in Italy” - CEQP.



The trade-mark states a wide range of technical features, concerning product quality and ability in customers’ service. With this trade-mark, Comerio Ercole guarantees to customers important product requirements and assures a greater transparency in the supply, confirming the good technical and technological features of the products “MADE IN ITALY” in the metal-mechanical and installation branches.

- 1) Manufacture and control of the product according to company **QUALITY** System ISO 9001:2000
- 2) **GUARANTEE** terms of 12 months starting from the commissioning date, but not later than 18 months from the shipping date.
- 3) Post-sale **CUSTOMER SERVICE** in order to offer a scheduled maintenance service, suitable and timely on different markets, with clear tariffs and certain times..
- 4) The supply of **Spare Parts** for at least 10 years, with store in warehouse and/or according to specific construction.
- 5) The respect of the most up-dated regulations concerning operators’ **SAFETY**.

In case of machinery included in the program “CEQP”, the metallic label will be applied at Comerio Ercole care, next to the serial no. label, in order to guarantee the easy identification.



Quality & Technology

Since 1885



**COMERIO ERCOLE**  
MECHANICAL CONSTRUCTIONS

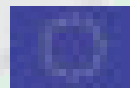



Choose the Original  
Choose Success!



**Comerio Ercole** have entered into an agreement with **Meccaniche Moderne Spa**, according to which any activity relating to the “rubber and plastics field” is now handled by **Comerio Ercole**.

The production range of machines and plants integrates perfectly with the production schedule of **Comerio Ercole**, therefore the customers will take advantage of the same conditions within a strengthened technical engagement.

- original spare parts for all **Meccaniche Moderne** installed machines and plants
- assistance service

**Quality & Technology**  
Since 1885



**COMERIO ERCOLE**  
MECHANICAL CONSTRUCTIONS







Choose the Original  
Choose Success!

## KOBELCO INTERMESHING ROTOR



Comerio Ercole supply in cooperation with Kobelco a new series of intermeshing type mixer improved intensive and distributive mixing from 14 up to 210 liter size.

## KOBELCO 4-Wing H Tangential



L&T Kobelco manufacture and supply 270 and 370 liter size tangential type mixer chambers to the European tire market with the support of Comerio Ercole.

*Quality &*  
**Technology**  
*Since 1885*



**COMERIO ERCOLE**  
MECHANICAL CONSTRUCTIONS

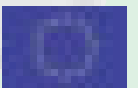

SINCERT



SINCERT



# RECYCLING EXTRUSION PLANT

System to produce high-tech composite sheets made with cheap raw materials. Single-screw vacuum extruder with a peculiar mixing chamber, in which the fillers are perfectly blended with the molten polymer. The whole system is designed in order that the filler is preserved intact and is not thermally altered. Suitable cooling and degassing systems are foreseen on the plant.



## ETP® PLANT MODELS

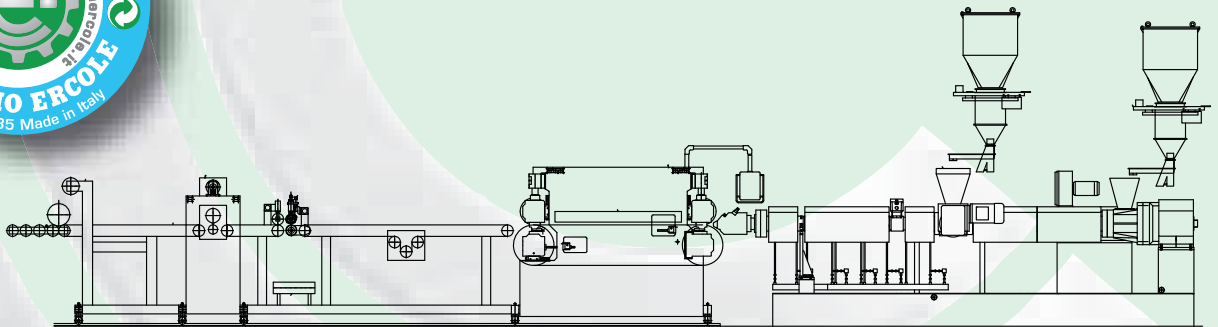

### USUAL RAW MATERIALS:

- Recycled rubber from tires and other rubber wastes
- Thermoplastic recycled polymer such as PP, PE, EVA, TPE
- Mineral fibers and fillers (e.g. glass fibers, carbon fibers)
- Sawdust, vegetal fibers (e.g. long flax, kenaf, wood fibers)
- Nonwovens fabrics, woven fabrics films, sheets

### MAIN ADVANTAGES:

- Wide range of materials combinations and composite products
- High fillers contents and dispersion
- Up to 90% recycled raw materials
- Products fully recyclable
- Lower wear of extruder barrel and screw

### MAIN APPLICATION:

- Acoustic and insulating panels
- Flooring and roofing
- Carpet coating
- Playground surfaces and sport mats
- Impact protection
- Agricultural and animal products
- Furnishing industry

Quality & Technology

Since 1885



**COMERIO ERCOLE**  
MECHANICAL CONSTRUCTIONS

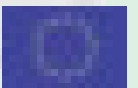



Photos by: Pino - Arca Comerio

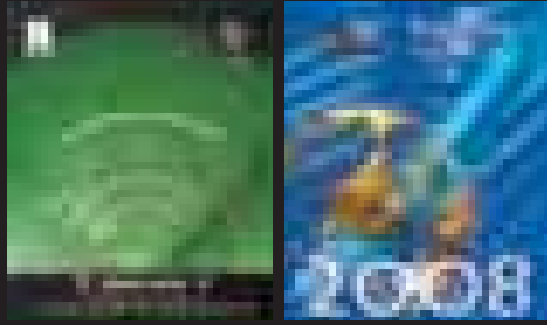
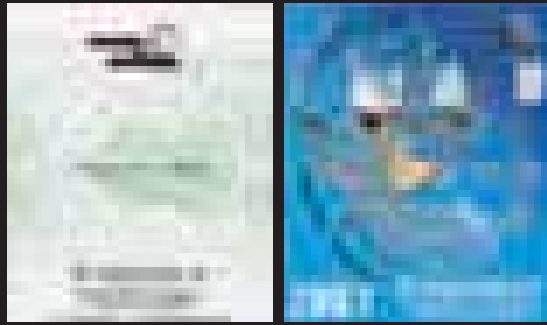
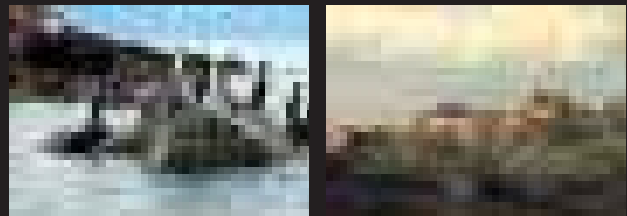
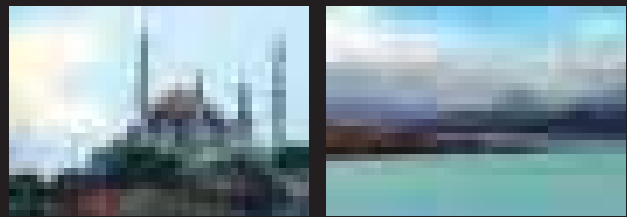
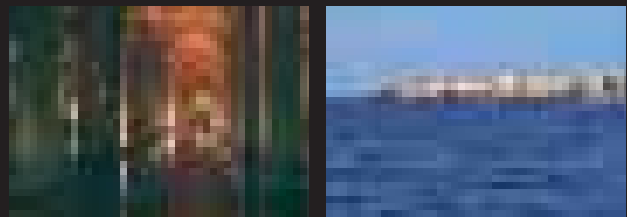
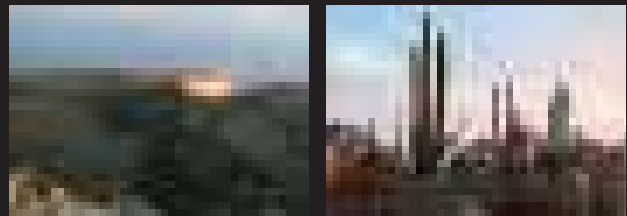
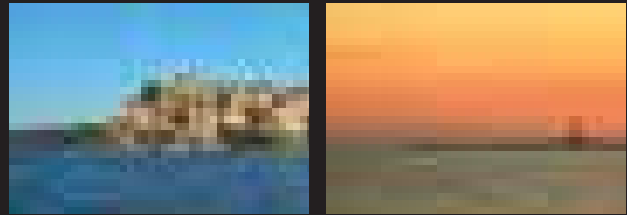
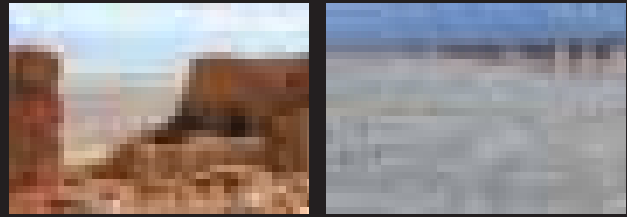

Quality & Technology  
Since 1885

Choose the Original  
Choose Success!

SINCE  
1885

[www.comercole.it](http://www.comercole.it)

[info@comercole.it](mailto:info@comercole.it)



**COMERIO ERCOLE**





ISRAEL - MASADA

**GENNAIO 2012 JANUARY**

|                | Lun<br>Mon | Mar<br>Tue | Mer<br>Wed | Giov<br>Thu | Ven<br>Fri | Sab<br>Sat | Dom<br>Sun |
|----------------|------------|------------|------------|-------------|------------|------------|------------|
|                |            |            |            |             |            |            | 1          |
| 1 <sup>a</sup> | 2          | 3          | 4          | 5           | 6          | 7          | 8          |
| 2 <sup>a</sup> | 9          | 10         | 11         | 12          | 13         | 14         | 15         |
| 3 <sup>a</sup> | 16         | 17         | 18         | 19          | 20         | 21         | 22         |
| 4 <sup>a</sup> | 23         | 24         | 25         | 26          | 27         | 28         | 29         |
| 5 <sup>a</sup> | 30         | 31         |            |             |            |            |            |

D  
I  
C  
E  
M  
B  
R  
E  
2  
0  
1  
1  
D  
E  
C  
E  
M  
B  
E  
R

gio 1  
ven 2  
sab 3  
dom 4  
lun 5  
mar 6  
mer 7  
gio 8  
ven 9  
sab 10  
dom 11  
lun 12  
mar 13  
mer 14  
gio 15  
ven 16  
sab 17  
dom 18  
lun 19  
mar 20  
mer 21  
gio 22  
ven 23  
sab 24  
dom 25  
lun 26  
mar 27  
mer 28  
gio 29  
ven 30  
sab 31

F  
E  
B  
B  
R  
A  
I  
O  
2  
0  
1  
2  
F  
E  
B  
R  
U  
A  
R  
Y

mer 1  
gio 2  
ven 3  
sab 4  
dom 5  
lun 6  
mar 7  
mer 8  
gio 9  
ven 10  
sab 11  
dom 12  
lun 13  
mar 14  
mer 15  
gio 16  
ven 17  
sab 18  
dom 19  
lun 20  
mar 21  
mer 22  
gio 23  
ven 24  
sab 25  
dom 26  
lun 27  
mar 28  
mer 29



**COMERIO ERCOLE**

MECHANICAL CONSTRUCTIONS SINCE 1885 - ITALY



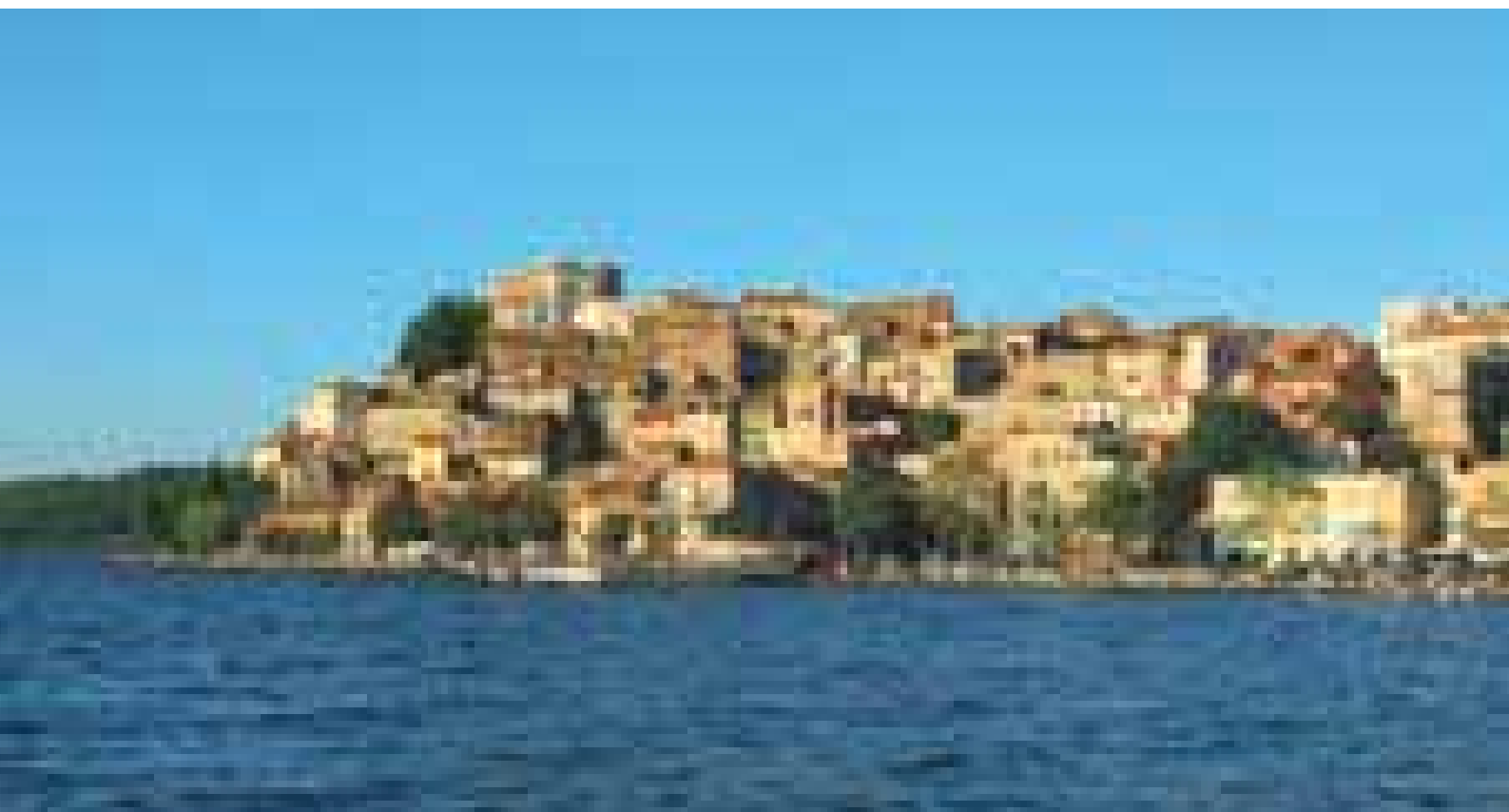

G  
E  
N  
N  
A  
I  
O  
2  
0  
1  
2  
J  
A  
N  
U  
A  
R  
Y  
 dom 1  
Lun 2  
mar 3  
mer 4  
gio 5  
ven 6  
sab 7  
dom 8  
Lun 9  
mar 10  
mer 11  
gio 12  
ven 13  
sab 14  
dom 15  
Lun 16  
mar 17  
mer 18  
gio 19  
ven 20  
sab 21  
dom 22  
Lun 23  
mar 24  
mer 25  
gio 26  
ven 27  
sab 28  
dom 29  
Lun 30  
mar 31

ITALY - ANGUILLARA - LIKE TRASIMENO

**FEBBRAIO 2012 FEBRUARY**

|                | Lun<br>Mon | Mar<br>Tue | Mer<br>Wed | Giov<br>Thu | Ven<br>Fri | Sab<br>Sat | Dom<br>Sun |
|----------------|------------|------------|------------|-------------|------------|------------|------------|
| 5 <sup>a</sup> |            |            | 1          | 2           | 3          | 4          | 5          |
| 6 <sup>a</sup> | 6          | 7          | 8          | 9           | 10         | 11         | 12         |
| 7 <sup>a</sup> | 13         | 14         | 15         | 16          | 17         | 18         | 19         |
| 8 <sup>a</sup> | 20         | 21         | 22         | 23          | 24         | 25         | 26         |
| 9 <sup>a</sup> | 27         | 28         | 29         |             |            |            |            |

M  
A  
R  
Z  
O  
2  
0  
1  
2  
M  
A  
R  
C  
H  
 gio 1  
ven 2  
sab 3  
dom 4  
Lun 5  
mar 6  
mer 7  
gio 8  
ven 9  
sab 10  
dom 11  
Lun 12  
mar 13  
mer 14  
gio 15  
ven 16  
sab 17  
dom 18  
Lun 19  
mar 20  
mer 21  
gio 22  
ven 23  
sab 24  
dom 25  
Lun 26  
mar 27  
mer 28  
gio 29  
ven 30  
sab 31



**COMERIO ERCOLE**

MECHANICAL CONSTRUCTIONS SINCE 1885 - ITALY





ETHIOPIA - VOLCANO ERTA ALE CALDERA

FEBBRAIO 2012 FEBRUARY

mer 1  
gio 2  
ven 3  
sab 4  
dom 5  
lun 6  
mar 7  
mer 8  
gio 9  
ven 10  
sab 11  
dom 12  
lun 13  
mar 14  
mer 15  
gio 16  
ven 17  
sab 18  
dom 19  
lun 20  
mar 21  
mer 22  
gio 23  
ven 24  
sab 25  
dom 26  
lun 27  
mar 28  
mer 29

MARZO 2012 MARCH

|                 | Lun<br>Mon | Mar<br>Tue | Mer<br>Wed | Giov<br>Thu | Ven<br>Fri | Sab<br>Sat | Dom<br>Sun |
|-----------------|------------|------------|------------|-------------|------------|------------|------------|
| 9 <sup>a</sup>  |            |            |            | 1           | 2          | 3          | 4          |
| 10 <sup>a</sup> | 5          | 6          | 7          | 8           | 9          | 10         | 11         |
| 11 <sup>a</sup> | 12         | 13         | 14         | 15          | 16         | 17         | 18         |
| 12 <sup>a</sup> | 19         | 20         | 21         | 22          | 23         | 24         | 25         |
| 13 <sup>a</sup> | 26         | 27         | 28         | 29          | 30         | 31         |            |

dom 1  
lun 2  
mar 3  
mer 4  
gio 5  
ven 6  
sab 7  
dom 8  
lun 9  
mar 10  
mer 11  
gio 12  
ven 13  
sab 14  
dom 15  
lun 16  
mar 17  
mer 18  
gio 19  
ven 20  
sab 21  
dom 22  
lun 23  
mar 24  
mer 25  
gio 26  
ven 27  
sab 28  
dom 29  
lun 30

APRILE 2012 APRIL



**COMERIO ERCOLE**

MECHANICAL CONSTRUCTIONS SINCE 1885 - ITALY





TURKEY - ISTANBUL - TEREBATAN SARAY

M  
A  
R  
Z  
O  
  
2  
0  
1  
2  
  
M  
A  
R  
C  
H

gio 1  
ven 2  
sab 3  
dom 4  
lun 5  
mar 6  
mer 7  
gio 8  
ven 9  
sab 10  
dom 11  
lun 12  
mar 13  
mer 14  
gio 15  
ven 16  
sab 17  
dom 18  
lun 19  
mar 20  
mer 21  
gio 22  
ven 23  
sab 24  
dom 25  
lun 26  
mar 27  
mer 28  
gio 29  
ven 30  
sab 31

APRILE 2012 APRIL

|                 | Lun<br>Mon | Mar<br>Tue | Mer<br>Wed | Giov<br>Thu | Ven<br>Fri | Sab<br>Sat | Dom<br>Sun |
|-----------------|------------|------------|------------|-------------|------------|------------|------------|
| 13 <sup>a</sup> |            |            |            |             |            |            | 1          |
| 14 <sup>a</sup> | 2          | 3          | 4          | 5           | 6          | 7          | 8          |
| 15 <sup>a</sup> | 9          | 10         | 11         | 12          | 13         | 14         | 15         |
| 16 <sup>a</sup> | 16         | 17         | 18         | 19          | 20         | 21         | 22         |
| 17 <sup>a</sup> | 23         | 24         | 25         | 26          | 27         | 28         | 29         |
| 18 <sup>a</sup> | 30         |            |            |             |            |            |            |

M  
A  
G  
G  
I  
O  
  
2  
0  
1  
2  
  
M  
A  
Y

mar 1  
mer 2  
gio 3  
ven 4  
sab 5  
dom 6  
lun 7  
mar 8  
mer 9  
gio 10  
ven 11  
sab 12  
dom 13  
lun 14  
mar 15  
mer 16  
gio 17  
ven 18  
sab 19  
dom 20  
lun 21  
mar 22  
mer 23  
gio 24  
ven 25  
sab 26  
dom 27  
lun 28  
mar 29  
mer 30  
gio 31



**COMERIO ERCOLE**



MECHANICAL CONSTRUCTIONS SINCE 1885 - ITALY



TURKEY - ISTANBUL - SULLEYMANIYE CAMII

A  
P  
R  
I  
L  
E  
2  
0  
1  
2  
A  
P  
R  
I  
L

dom 1  
lun 2  
mar 3  
mer 4  
gio 5  
ven 6  
sab 7  
dom 8  
lun 9  
mar 10  
mer 11  
gio 12  
ven 13  
sab 14  
dom 15  
lun 16  
mar 17  
mer 18  
gio 19  
ven 20  
sab 21  
dom 22  
lun 23  
mar 24  
mer 25  
gio 26  
ven 27  
sab 28  
dom 29  
lun 30

MAGGIO 2012 MAY

|                 | Lun<br>Mon | Mar<br>Tue | Mer<br>Wed | Giov<br>Thu | Ven<br>Fri | Sab<br>Sat | Dom<br>Sun |
|-----------------|------------|------------|------------|-------------|------------|------------|------------|
| 18 <sup>a</sup> |            | 1          | 2          | 3           | 4          | 5          | 6          |
| 19 <sup>a</sup> | 7          | 8          | 9          | 10          | 11         | 12         | 13         |
| 20 <sup>a</sup> | 14         | 15         | 16         | 17          | 18         | 19         | 20         |
| 21 <sup>a</sup> | 21         | 22         | 23         | 24          | 25         | 26         | 27         |
| 22 <sup>a</sup> | 28         | 29         | 30         | 31          |            |            |            |

G  
I  
U  
G  
N  
O  
2  
0  
1  
2  
J  
U  
N  
E

ven 1  
sab 2  
dom 3  
lun 4  
mar 5  
mer 6  
gio 7  
ven 8  
sab 9  
dom 10  
lun 11  
mar 12  
mer 13  
gio 14  
ven 15  
sab 16  
dom 17  
lun 18  
mar 19  
mer 20  
gio 21  
ven 22  
sab 23  
dom 24  
lun 25  
mar 26  
mer 27  
gio 28  
ven 29  
sab 30



**COMERIO ERCOLE**

MECHANICAL CONSTRUCTIONS SINCE 1885 - ITALY







MEXICO - BAJA CALIFORNIA

M  
A  
G  
G  
I  
O  
2  
0  
1  
2  
M  
A  
Y  
mar 1  
mer 2  
gio 3  
ven 4  
sab 5  
dom 6  
lun 7  
mar 8  
mer 9  
gio 10  
ven 11  
sab 12  
dom 13  
lun 14  
mar 15  
mer 16  
gio 17  
ven 18  
sab 19  
dom 20  
lun 21  
mar 22  
mer 23  
gio 24  
ven 25  
sab 26  
dom 27  
lun 28  
mar 29  
mer 30  
gio 31

| GIUGNO 2012 JUNE |            |            |            |             |            |            |            |
|------------------|------------|------------|------------|-------------|------------|------------|------------|
|                  | Lun<br>Mon | Mar<br>Tue | Mer<br>Wed | Giov<br>Thu | Ven<br>Fri | Sab<br>Sat | Dom<br>Sun |
| 22 <sup>a</sup>  |            |            |            |             | 1          | 2          | 3          |
| 23 <sup>a</sup>  | 4          | 5          | 6          | 7           | 8          | 9          | 10         |
| 24 <sup>a</sup>  | 11         | 12         | 13         | 14          | 15         | 16         | 17         |
| 25 <sup>a</sup>  | 18         | 19         | 20         | 21          | 22         | 23         | 24         |
| 26 <sup>a</sup>  | 25         | 26         | 27         | 28          | 29         | 30         |            |

dom 1  
lun 2  
mar 3  
mer 4  
gio 5  
ven 6  
sab 7  
dom 8  
lun 9  
mar 10  
mer 11  
gio 12  
ven 13  
sab 14  
dom 15  
lun 16  
mar 17  
mer 18  
gio 19  
ven 20  
sab 21  
dom 22  
lun 23  
mar 24  
mer 25  
gio 26  
ven 27  
sab 28  
dom 29  
lun 30  
mar 31

L  
U  
G  
L  
I  
O  
2  
0  
1  
2  
J  
U  
L  
Y



**COMERIO ERCOLE**

MECHANICAL CONSTRUCTIONS SINCE 1885 - ITALY





ETHIOPIA - SALT PLAIN

G  
I  
U  
G  
N  
O  
2  
0  
1  
2  
J  
U  
N  
E

ven 1  
sab 2  
dom 3  
lun 4  
mar 5  
mer 6  
gio 7  
ven 8  
sab 9  
dom 10  
lun 11  
mar 12  
mer 13  
gio 14  
ven 15  
sab 16  
dom 17  
lun 18  
mar 19  
mer 20  
gio 21  
ven 22  
sab 23  
dom 24  
lun 25  
mar 26  
mer 27  
gio 28  
ven 29  
sab 30

LUGLIO 2012 JULY

|                 | Lun<br>Mon | Mar<br>Tue | Mer<br>Wed | Giov<br>Thu | Ven<br>Fri | Sab<br>Sat | Dom<br>Sun |
|-----------------|------------|------------|------------|-------------|------------|------------|------------|
| 26 <sup>a</sup> |            |            |            |             |            |            | 1          |
| 27 <sup>a</sup> | 2          | 3          | 4          | 5           | 6          | 7          | 8          |
| 28 <sup>a</sup> | 9          | 10         | 11         | 12          | 13         | 14         | 15         |
| 29 <sup>a</sup> | 16         | 17         | 18         | 19          | 20         | 21         | 22         |
| 30 <sup>a</sup> | 23         | 24         | 25         | 26          | 27         | 28         | 29         |
| 31 <sup>a</sup> | 30         | 31         |            |             |            |            |            |

mer 1  
gio 2  
ven 3  
sab 4  
dom 5  
lun 6  
mar 7  
mer 8  
gio 9  
ven 10  
sab 11  
dom 12  
lun 13  
mar 14  
mer 15  
gio 16  
ven 17  
sab 18  
dom 19  
lun 20  
mar 21  
mer 22  
gio 23  
ven 24  
sab 25  
dom 26  
lun 27  
mar 28  
mer 29  
gio 30  
ven 31

A  
G  
O  
S  
T  
O  
2  
0  
1  
2  
A  
U  
G  
U  
S  
T



**COMERIO ERCOLE**



MECHANICAL CONSTRUCTIONS SINCE 1885 - ITALY



ITALY - GALLIPOLI - LIGHTHOUSE

L  
U  
G  
L  
I  
O  
  
2  
0  
1  
2  
  
J  
U  
L  
Y

dom 1  
lun 2  
mar 3  
mer 4  
gio 5  
ven 6  
sab 7  
dom 8  
lun 9  
mar 10  
mer 11  
gio 12  
ven 13  
sab 14  
dom 15  
lun 16  
mar 17  
mer 18  
gio 19  
ven 20  
sab 21  
dom 22  
lun 23  
mar 24  
mer 25  
gio 26  
ven 27  
sab 28  
dom 29  
lun 30  
mar 31

| AGOSTO          |            | 2012       |            |             |            |            | AUGUST     |  |
|-----------------|------------|------------|------------|-------------|------------|------------|------------|--|
|                 | Lun<br>Mon | Mar<br>Tue | Mer<br>Wed | Giov<br>Thu | Ven<br>Fri | Sab<br>Sat | Dom<br>Sun |  |
| 31 <sup>a</sup> |            |            | 1          | 2           | 3          | 4          | 5          |  |
| 32 <sup>a</sup> | 6          | 7          | 8          | 9           | 10         | 11         | 12         |  |
| 33 <sup>a</sup> | 13         | 14         | 15         | 16          | 17         | 18         | 19         |  |
| 34 <sup>a</sup> | 20         | 21         | 22         | 23          | 24         | 25         | 26         |  |
| 35 <sup>a</sup> | 27         | 28         | 29         | 30          | 31         |            |            |  |

S  
E  
T  
T  
E  
M  
B  
R  
E  
  
2  
0  
1  
2  
  
S  
E  
P  
T  
E  
M  
B  
E  
R

sab 1  
dom 2  
lun 3  
mar 4  
mer 5  
gio 6  
ven 7  
sab 8  
dom 9  
lun 10  
mar 11  
mer 12  
gio 13  
ven 14  
sab 15  
dom 16  
lun 17  
mar 18  
mer 19  
gio 20  
ven 21  
sab 22  
dom 23  
lun 24  
mar 25  
mer 26  
gio 27  
ven 28  
sab 29  
dom 30



**COMERIO ERCOLE**



MECHANICAL CONSTRUCTIONS SINCE 1885 - ITALY



MEXICO - BAJA CALIFORNIA

# SETTEMBRE 2012 SEPTEMBER

|                 | Lun<br>Mon | Mar<br>Tue | Mer<br>Wed | Giov<br>Thu | Ven<br>Fri | Sab<br>Sat | Dom<br>Sun |
|-----------------|------------|------------|------------|-------------|------------|------------|------------|
| 35 <sup>a</sup> |            |            |            |             |            | 1          | 2          |
| 36 <sup>a</sup> | 3          | 4          | 5          | 6           | 7          | 8          | 9          |
| 37 <sup>a</sup> | 10         | 11         | 12         | 13          | 14         | 15         | 16         |
| 38 <sup>a</sup> | 17         | 18         | 19         | 20          | 21         | 22         | 23         |
| 39 <sup>a</sup> | 24         | 25         | 26         | 27          | 28         | 29         | 30         |

AUGUSTO  
2012  
AUGUST

mer 1  
gio 2  
ven 3  
sab 4  
dom 5  
lun 6  
mar 7  
mer 8  
gio 9  
ven 10  
sab 11  
dom 12  
lun 13  
mar 14  
mer 15  
gio 16  
ven 17  
sab 18  
dom 19  
lun 20  
mar 21  
mer 22  
gio 23  
ven 24  
sab 25  
dom 26  
lun 27  
mar 28  
mer 29  
gio 30  
ven 31

OCTOBRE  
2012  
OCTOBER

lun 1  
mar 2  
mer 3  
gio 4  
ven 5  
sab 6  
dom 7  
lun 8  
mar 9  
mer 10  
gio 11  
ven 12  
sab 13  
dom 14  
lun 15  
mar 16  
mer 17  
gio 18  
ven 19  
sab 20  
dom 21  
lun 22  
mar 23  
mer 24  
gio 25  
ven 26  
sab 27  
dom 28  
lun 29  
mar 30  
mer 31



**COMERIO ERCOLE**

MECHANICAL CONSTRUCTIONS SINCE 1885 - ITALY





ITALY - GALLIPOLI

OTTOBRE 2012 OCTOBER

|                 | Lun<br>Mon | Mar<br>Tue | Mer<br>Wed | Giov<br>Thu | Ven<br>Fri | Sab<br>Sat | Dom<br>Sun |
|-----------------|------------|------------|------------|-------------|------------|------------|------------|
| 40 <sup>a</sup> | 1          | 2          | 3          | 4           | 5          | 6          | 7          |
| 41 <sup>a</sup> | 8          | 9          | 10         | 11          | 12         | 13         | 14         |
| 42 <sup>a</sup> | 15         | 16         | 17         | 18          | 19         | 20         | 21         |
| 43 <sup>a</sup> | 22         | 23         | 24         | 25          | 26         | 27         | 28         |
| 44 <sup>a</sup> | 29         | 30         | 31         |             |            |            |            |

S  
E  
T  
T  
E  
M  
B  
R  
E  
2  
0  
1  
2  
S  
E  
P  
T  
E  
M  
B  
R

sab 1  
dom 2  
lun 3  
mar 4  
mer 5  
gio 6  
ven 7  
sab 8  
dom 9  
lun 10  
mar 11  
mer 12  
gio 13  
ven 14  
sab 15  
dom 16  
lun 17  
mar 18  
mer 19  
gio 20  
ven 21  
sab 22  
dom 23  
lun 24  
mar 25  
mer 26  
gio 27  
ven 28  
sab 29  
dom 30

N  
O  
V  
E  
M  
B  
R  
E  
2  
0  
1  
2  
N  
O  
V  
E  
M  
B  
R

gio 1  
ven 2  
sab 3  
dom 4  
lun 5  
mar 6  
mer 7  
gio 8  
ven 9  
sab 10  
dom 11  
lun 12  
mar 13  
mer 14  
gio 15  
ven 16  
sab 17  
dom 18  
lun 19  
mar 20  
mer 21  
gio 22  
ven 23  
sab 24  
dom 25  
lun 26  
mar 27  
mer 28  
gio 29  
ven 30



**COMERIO ERCOLE**



MECHANICAL CONSTRUCTIONS SINCE 1885 - ITALY



O T T O B R E  
 2 0 1 2  
 O C T O B E R

lun 1  
 mar 2  
 mer 3  
 gio 4  
 ven 5  
 sab 6  
 dom 7  
 lun 8  
 mar 9  
 mer 10  
 gio 11  
 ven 12  
 sab 13  
 dom 14  
 lun 15  
 mar 16  
 mer 17  
 gio 18  
 ven 19  
 sab 20  
 dom 21  
 lun 22  
 mar 23  
 mer 24  
 gio 25  
 ven 26  
 sab 27  
 dom 28  
 lun 29  
 mar 30  
 mer 31

MEXICO - BAJA CALIFORNIA

## NOVEMBRE 2012 NOVEMBER

|                 | Lun<br>Mon | Mar<br>Tue | Mer<br>Wed | Giov<br>Thu | Ven<br>Fri | Sab<br>Sat | Dom<br>Sun |
|-----------------|------------|------------|------------|-------------|------------|------------|------------|
| 44 <sup>a</sup> |            |            |            | 1           | 2          | 3          | 4          |
| 45 <sup>a</sup> | 5          | 6          | 7          | 8           | 9          | 10         | 11         |
| 46 <sup>a</sup> | 12         | 13         | 14         | 15          | 16         | 17         | 18         |
| 47 <sup>a</sup> | 19         | 20         | 21         | 22          | 23         | 24         | 25         |
| 48 <sup>a</sup> | 26         | 27         | 28         | 29          | 30         |            |            |

sab 1  
 dom 2  
 lun 3  
 mar 4  
 mer 5  
 gio 6  
 ven 7  
 sab 8  
 dom 9  
 lun 10  
 mar 11  
 mer 12  
 gio 13  
 ven 14  
 sab 15  
 dom 16  
 lun 17  
 mar 18  
 mer 19  
 gio 20  
 ven 21  
 sab 22  
 dom 23  
 lun 24  
 mar 25  
 mer 26  
 gio 27  
 ven 28  
 sab 29  
 dom 30  
 lun 31

D I C E M B R E  
 2 0 1 2  
 D E C E M B E R



**COMERIO ERCOLE**

MECHANICAL CONSTRUCTIONS SINCE 1885 - ITALY





NOVEMBRE 2012 NOVEMBRE

ITALY - OSTUNI

# DICEMBRE 2012 DECEMBER

|                 | Lun<br>Mon | Mar<br>Tue | Mer<br>Wed | Giov<br>Thu | Ven<br>Fri | Sab<br>Sat | Dom<br>Sun |
|-----------------|------------|------------|------------|-------------|------------|------------|------------|
| 48 <sup>a</sup> |            |            |            |             |            | 1          | 2          |
| 49 <sup>a</sup> | 3          | 4          | 5          | 6           | 7          | 8          | 9          |
| 50 <sup>a</sup> | 10         | 11         | 12         | 13          | 14         | 15         | 16         |
| 51 <sup>a</sup> | 17         | 18         | 19         | 20          | 21         | 22         | 23         |
| 52 <sup>a</sup> | 24         | 25         | 26         | 27          | 28         | 29         | 30         |
|                 | 31         |            |            |             |            |            |            |

gio 1  
 ven 2  
 sab 3  
 dom 4  
 lun 5  
 mar 6  
 mer 7  
 gio 8  
 ven 9  
 sab 10  
 dom 11  
 lun 12  
 mar 13  
 mer 14  
 gio 15  
 ven 16  
 sab 17  
 dom 18  
 lun 19  
 mar 20  
 mer 21  
 gio 22  
 ven 23  
 sab 24  
 dom 25  
 lun 26  
 mar 27  
 mer 28  
 gio 29  
 ven 30

mar 1  
 mer 2  
 gio 3  
 ven 4  
 sab 5  
 dom 6  
 lun 7  
 mar 8  
 mer 9  
 gio 10  
 ven 11  
 sab 12  
 dom 13  
 lun 14  
 mar 15  
 mer 16  
 gio 17  
 ven 18  
 sab 19  
 dom 20  
 lun 21  
 mar 22  
 mer 23  
 gio 24  
 ven 25  
 sab 26  
 dom 27  
 lun 28  
 mar 29  
 mer 30  
 gio 31

GENNAIO 2013 JANUARY



**COMERIO ERCOLE**



MECHANICAL CONSTRUCTIONS SINCE 1885 - ITALY